





















FORD Replace parts ESCORT, FIESTA

 <p>LHC0001 69IF-6038-AB ESCORT ENGINE MOUNT, F</p>	 <p>75AG-4826-BA ESCORT 75-78 CUSHION, ASSY</p>	 <p>LHC0818 10*41*125*9 ESCORT, CHRYSLER STEERING BOOT</p>
 <p>LHC0002 69IF-6068-BB ESCORT ENGINE MOUNT, R</p>	 <p>LHC0015 74AB-5484-0A ESCORT STABILIZER BUSH</p>	 <p>LHC0819 10*32*166*9 ESCORT, CHRYSLER STEERING BOOT</p>
 <p>LHC0003 69EB-3063-AB ESCORT SUSPENSION BUSH</p>	 <p>LHC0016 75AB-5710-AA ESCORT SPRING BUSH</p>	 <p>LHC0976-11 1661237 FORD FIESTA '90 STAB. KIT</p>
 <p>LHC0004 30241E-54930 ESCORT SUSPENSION BUSH</p>	 <p>6087888 RH 6087889 LH ESCORT III 80-86 LOW ARM</p>	
 <p>LHC0914 105E-3063A ESCORT ARM BUSH</p>	 <p>86AB-3078-AA RH 86AB-3079-AA LH ESCORT IV 87-90 LOW ARM</p>	
 <p>LHC0006 68AB-3K661-BA ESCORT STEERING BOOT</p>	 <p>E8EZ-6038B MT E9EZ-6038B AT FIESTA 1988</p>	
 <p>LHC0007 69AB-3K668-AA ESCORT STEERING BOOT</p>	 <p>E8EZ-6038A FIESTA 1988 ENGINE MOUNT, F</p>	 <p>FOBZ-6068B MT FOBZ-6068A AT FIESTA 1988 TRANS MOUNT</p>
 <p>LHC0008 3024E-3K576-A ESCORT INSULATOR</p>		
 <p>LHC0009 3024E-3K573-A ESCORT INSULATOR</p>		
 <p>LHC0010 75AB-5781-AA ESCORT SPRING BUSH</p>		

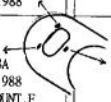
FORD replace parts FIESTA, FUSION 2002~



RADIATOR HOSE

1.4 : 2S6H-8B274BA UPPER
2S6H-8B273BC LOWER

OIL CAP

YS4G-6766AA 1.4
2S6Q-6766AA 1.6

ENGINE MOUNT

2S61-7M121BB

TRANS

3S61-6P082AA

1.4: 2S61-6F012AD

1.6: 5S61-6F012BA
DIE

2.0: 2S61-6F012CB

STEERING LINK

TIE ROD END

2S6J-3289AC RH

RACK END
2S6C-3280KA

BUSH
2S6C-3C176AA

2S6C-3K661JB

TIE ROD END
2S6J-3290AC LH

BOOT

FRONT SUSPENSION



BALL JOINT:
2S61-3555AH

BUSH:
2S61-3063CA

BUSH W/ASSY:
2S61-3A262AC

BUSH ONLY:
2S61-3A262B

LOWER ARM:
RH: 2S61-3042AH
LH: 2S61-3051AH

2S61-3K155



2S61-3B438AD 2S61-3K099



2S61-3K036



2S61-5484DA



2S61-3025



REAR SUSPENSION



BUSH:
2S61-5K653AG



MUFFLER HANGER
2S61-5A262BB
3M51-5A262EB

2S61-5K570AA



ESCORT, MERCURY TRACER

XS4Z-6038-AA
ESCORT 1997
MERCURY TRACER
ENG. MOUNT, RH



XS4Z-6038-AB
WITHOUT BRACKET
REAR MOUNT, UPPER

XS4Z-6038-ASSY
WITH BRACKET ASSY



F7CZ-6038-EA
ESCORT 1997
MERCURY TRACER
ENG. MOUNT, F



F7CZ-6068-AC
ESCORT 1997
MERCURY TRACER
REAR MOUNT, LOWER



F7CZ-5493-AA
STABILIZER BUSH



F7CZ-6068BB
AT TRANS MOUNT

F1CZ-5A486-AA
STAB. KIT



FOCZ-18A161-AA
STRUT MOUNT, F



F7CZ-3C134-BA
STRUT BOOT



F7CZ-18197-AA
STRUT MOUNT, R

F7CZ-18159-AA
STRUT BOOT, R

RH F7CZ-3078-AH F7CZ-3078-BB RH
LH F7CZ-3079-AH F7CZ-3079-BB LH

F7CZ-3069-CA
ARM BUSH

F7CZ-3050-AA



F7CZ-5500-CA RH
F7CZ-5500-BA LH

F7CZ-5500-AA

F7CZ-5K898-AA



 <p>LHC0021 711F-6038-AA CORTINA ENGINE MOUNT, F</p>	 <p>LHC0031 71BB-5A638-EB CORTINA BUSH</p>	 <p>LHC0041 76BB-3K576-AA CORTINA INSULATOR</p>
 <p>LHC0022 70HF-6068-AB CORTINA 'L ENG MOUNT, R</p>	 <p>LHC0032 71BB-5K789-AA CORTINA AXLE BUSH</p>	 <p>LHC0042 71BB-18016-BA CORTINA ABSORBER BUSH</p>
 <p>LHC0023 711F-8068-AB CORTINA ENGINE MOUNT, R</p>	 <p>LHC0033 74BB-3068-AA CORTINA SUSP. BUSH, UPR</p>	 <p>LHC0043 69EB-18016-AA CORTINA ABSORBER BUSH</p>
 <p>LHC0024 71BG-4828-DA CORTINA CUSHION, ASSY</p>	 <p>LHC0034 74BB-3069-AB CORTINA SUSP. BUSH, LOR</p>	 <p>LHC0044 CORTINA STEERING KIT, 6PCS</p>
 <p>LHC0025 0440888-AA CORTINA CUSHION</p>	 <p>LHC0035 74BB-3470-AA CORTINA TIE BAR BUSH</p>	 <p>LHC0045 CORTINA CALIPER KIT</p>
 <p>LHC0026 74EB-5484-AA CORTINA STABILIZE BUSH</p>	 <p>LHC0036 691F-8260-AA CORTINA RADI. HOSE, UPR</p>	 <p>LHC0046 71BG-T28630-AA CORTINA HOSE, FILLER</p>
 <p>LHC0027 74BB-5L021-AA CORTINA FRAME BUSH</p>	 <p>LHC0037 691F-8286-AA CORTINA RADI. HOSE, LOR</p>	 <p>LHC0047 71HF-6K614-BD CORTINA OIL CAP</p>
 <p>LHC0028 74BB-5A103-AA CORTINA FRAME BUSH</p>	 <p>LHC2948 74BB-5484-AA CORTINA STABILIZER BUSH</p>	 <p>LHC0048 C7KH-9B559-A CORTINA DIAPHRAGM</p>
 <p>LHC0029 71BB-5K790-BB CORTINA SUSP. BUSH, R</p>	 <p>LHC0039 72BB-7A624-AA CORTINA PEDAL PAD</p>	 <p>LHC0049 CORTINA CARBURETOR RUBBER</p>
 <p>LHC0030 71BB-5K792-AB CORTINA BUSH</p>	 <p>LHC0040 71BB-3K573-AD CORTINA INSULATOR</p>	 <p>LHC0050 CORTINA BUMPER</p>

FORD Replace parts CORTINA

 LHC0051 CORTINA BONNET RUBBER.F	 LHC0061 CORTINA '80 RADIATOR HOSE, UP	 LHC2949 71BB-2128-CA(17.7mm) 71BB-2128-AA(17.7mm) CORTINA WHEEL KIT
 LHC0052 CORTINA BONNET RUBBER.R	 LHC0062 CORTINA '80 RADI. HOSE, LOWER	 LHC2950 3026B-2004-BC CORTINA BRAKE MASTER KIT
 LHC0053 E62-CP-7 CORTINA TENSIONER	 LHC0063 76BB-5K792-AA CORTINA '80 AXLE BUSH	 LHCV63 OPEL RECORD FORD SENATOR CV JOINT BOOT
 LHC0054 71BB-3K061-BA CORTINA STEERING BOOT	 LHC4179 71BB-5K498-BB CORTINA SIDE STAB BUSH	 LHC4194 81AB-3063-AA FORD ARM BUSH
 LHC0055 71BB-3K668-BA CORTINA STEERING BOOT	 LHC3323 CORTINA BRAKE SHOE KIT	 LHC4179K FORD STABILIZER KIT
 LHC0056 75EB-2078-AA CORTINA BRAKE HOSE	 LHC0066 FORD 2000cc RADI. HOSE, UPPER	 LHC4422 I. D. 12mm 74BC-5A103-AA FORD FRAME BUSH
 LHC0057 CORTINA BYPASS HOSE	 LHC0067 FORD 2000cc RADI. HOSE, LOWER	 LHC4421 77BC-5L021-AA FORD MK5 FRAME BUSH
 LHC0058 72GB-5281-AA CORTINA MUFFLER SUPPORT	 LHC0068 FORD 2000cc RADI. HOSE, UPPER	 LHC0147-11 82BC-5781-AA 93PX-28-330 SPRING BUSH
 LHC0038 72GB-3470-AA CORTINA BUSH	 LHC3551 12mm FORD WIPER GROMMET	 LHC0147-11 81AB-51987-BA FORD SUSPENSION BUSH
 LHC0059 AR5067 74BB-5719-BB CORTINA 71-80 SPRING BUSH	 LHC3550 16mm FORD WIPER GROMMET	 LHC6731 6172154 CORTINA GEAR LEVER KIT

FORD Replace parts GRANADA, SIERRA

	LHC0071 GRANADA GL ENGINE MOUNT, F		LHC0081 I.D. 14.5mm 72GB-5A103-BB GRANADA GL FRAME BUSH		LHC0091 GRANADA GLE RADI. HOSE, LOR
	LHC0023 711F-6068-AB GRANADA ENG. MOUNT, R		LHC0082 GRANADA GL HEATER HOSE		LHC0092 82GG-4684-AA GRANADA GLE COUPLING
	LHC0073 72GB-3068-AC GRANADA GL ARM BUSH, UPPER		LHC0083 78BG-8260-BA GRANADA GL HOSE, UPPER		LHC2599 87BB-8260-CB SIERRA RADI. HOSE, UPPER
	LHC0074 72GB-3069-AC GRANADA GL ARM BUSH, LOWER		LHC0084 78BG-8286-CA GRANADA GL HOSE, LOWER		LHC2023 SIERRA 2.0 STEERING BOOT
	LHC0075 72GG-4684-BA GRANADA GL COUPLING		LHC0085 GRANADA GL P/STEERING HOSE		LHC1917 77FB-5A262CA SIERRA MUFFLER SUPPORT
	LHC0076 74BB-3B197-AA GRANADA TIE BAR BUSH		LHC0086 GRANADA GL CUSHION, ASSY		LHC2437 85GB-5493-AB SIERRA SUSP. BUSH
	LHC0077 GRANADA STEERING BOOT		LHC1921 5*8*890 GRANDA GLE P/STEERING HOSE		LHC2190 85HF-6038-EA SIERRA ENG. MOUNT, F
	LHC0078 GRANADA GL PROPELLER BOOT		LHC0088 GRANADA GLE STEERING BOOT		LHC2525 85AB-2B507-AA SIERRA WHEEL KIT
	LHC0079 GRANADA GL CARBU. DIAPHRAGM		LHC3055 SIERRA COUPLING		LHC2452 83BB-5K817-BA SIERRA SUSP. BUSH
	LHC0080 72GB-5L021-BB GRANADA GL FRAME BUSH		LHC2600 87BB-8286-BB SIERRA RADI. HOSE, LOWER		LHC1919 83BB-5484-CQ SIERRA STABILIZER BUSH

	LHC2913 16x SIERRA 85-88 STEERING HOSE
--	---

	LHC4560 85GB-6068-AA SIERRA '85 ENG. MOUNT, R
--	--

	LHC0086-11 SIERRA CUSHION, ASSY
--	---------------------------------------

	LHC6732 GRANADA STAB. KIT
--	---------------------------------

	93BB-3042-BC RH 93BB-3051-BC LH MONDEO '93-95 SUSPENSION ARM
--	---

	97BG-3042-AA RH 97BG-3051-AA LH MONDEO '97 SUSPENSION ARM
---	--

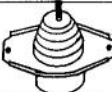
	LHC4145 91DA-6068-AA FORD ENGINE MOUNT
--	---

	LHC4087 93BB-3063-AA MONDEO ARM BUSH FRONT
---	---

	LHC6728 93BB-3B438-CA MONDEO STAB. KIT
---	---

	LHC6729 93BB-5K566-AC MONDEO '93 LINK, R
---	---

	LHC6730 93BB-5K566-AF MONDEO '97 LINK, R
---	---

	LHC4488 97BB-3063-AA MONDEO '97 ARM BUSH
---	---

	LHC4976 93BB-18198-BC MONDEO STRUT MOUNT REAR
---	--

	LHC4977 93BB-3K155-AC MONDEO STRUT MOUNT FRONT
---	---

	95GB-3B438-AD SCORPIO '95 2.3 STAB. LINK, F
---	---

	95GB-5K566-AA SCORPIO '95 2.3 STAB. LINK, R
---	---



RADIATOR HOSE

Upper
LHC5052



ENGINE MOUNT

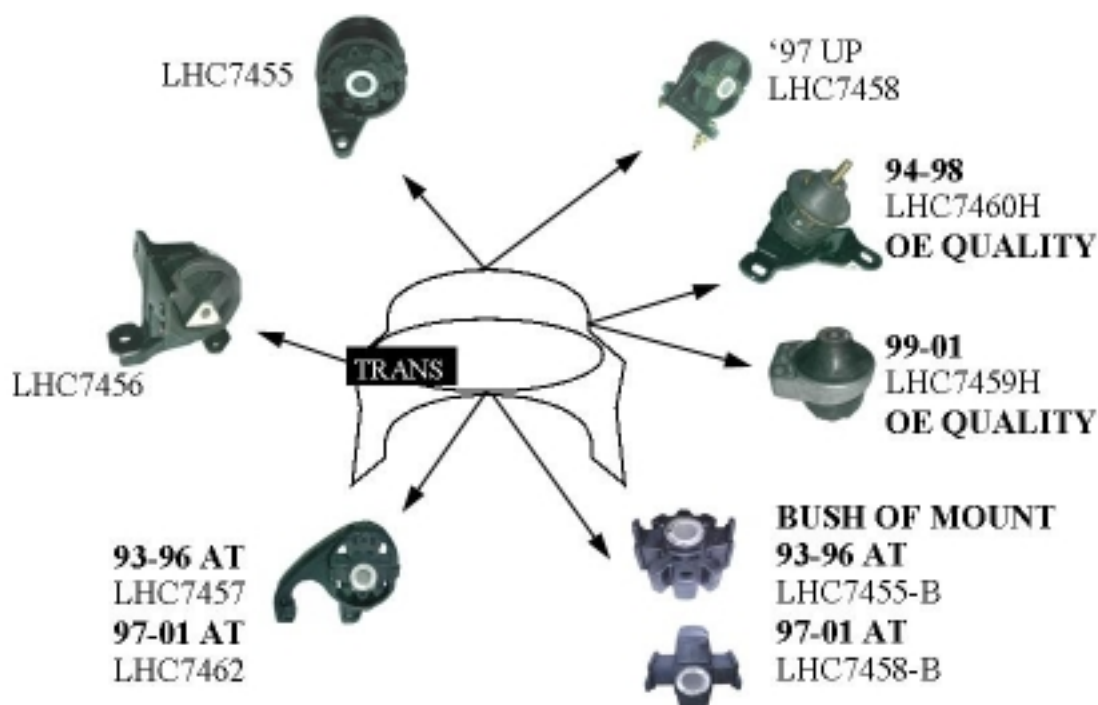

DRIVE AXLE

Outer:
93BG-3L537AB



Inner:
93BG-3A331AA

STEERING LINK

FRONT SUSPENSION

Arm:
RH:93BB-3042BC
LH:93BB-3051BC

Bush
LHC4087

BUSH
LHC4488



93BB-5484AB

LHC6728

LHC4977

93BB-3025AA

93BB-3K036AB

REAR SUSPENSION

LHC4976

93-96:LHC6729K
97-01:LHC6730K

93BB-3K036AB

LHC6611 18mm
LHC6612 16mm

Bush:
93BB-5K792AB

Rear Arm:
93BB-5K652AC

Front Arm:
93BB-5K743AC

Trailing Arm
93BB-5K898AF

Bush:
93BB-5K896AC

KNUCKLE BUSH
OD. 36.6mm ; 93BB-5K653AB
OD. 38.4mm ; 93BB-5K896AC

	LHC1701 XW6068C COMMODORE, FALCON ZEPHYR, HOLDEN ENGINE MOUNT, R		LHC1711 FORD STEERING COUPLING		LHC2922 TOPAZ ENGINE MOUNT, F
	LHC1702 FORD COUGAR ENG. MOUNT, R		LHC3709 9x43x200x9 USA CAR STEERING BOOT		LHC2986 TOPAZ RADI.HOSE,UPPER
	LHC1703 FORD MERCURY ARM BUSH		LHC2027 11*59*190*9 USA CAR STEERING BOOT		LHC2987 TOPAZ RADI.HOSE,LOWER
	LHC1704 FORD MERCURY ARM BUSH		LHC2075 11*51*225*12 USA CAR STEERING BOOT		
	LHC1705 FORD STEERING BOOT		LHC2077 11*54*190*11 USA CAR STEERING BOOT		LHC2895 SABLE RADI.HOSE,UPPER
	LHC1706 FORD STEERING BOOT		LHC1752 SABLE, HOLDEN P/STEERING BOOT		LHC2917 SABLE RADI.HOSE,LOWER
	LHC1707 FORD STABILIZER BUSH		LHC1751 11*58*190*15 HOLDEN STEERING BOOT		LHC3143 SABLE STRUT MOUNT,R
	LHC1708 E11C-5484-A FORD 3.3 STABILIZER BUSH		LHC2020 10x21x580 USA CAR HEATER HOSE		LHC3591 FORD POWER PUMP CAP
	LHC1709 FORD ZEPHYR RADI. HOSE,UPR		LHC3421 11X32X165 SBR-04 FORD STEERING BOOT		LHC4714 96DA-6C010-AA FORD '96 ENGINE MOUNT
	LHC3093 TEM1115 7432236 HOLDEN, COMMODORE ENGINE MOUNT, R		LHC3754 TEM1156 2823491 HOLDEN, COMMODORE ENGINE MOUNT		LHC4144 FORD MUSTAN ARM BUSH

USA

FORD Replace parts **MERCURY, WINDSTAR, MARQUIS, LS**

F4DZ-5K484
FORD SABLE
LINK KIT



F4AZ-5K-484A
MARQUIS'90
STAB.LINK,F



F3LY-5K-484A
MARQUIS'93
STAB.LINK,F



F58A-5K483-CB
WINDSTAR 3.0
STAB.LINK,F



F6AZ-5K-484A
MARQUIS'95
STAB.LINK,F









1W4Z-5K-484A
LS 00-03 3.0
STAB.KIT,F





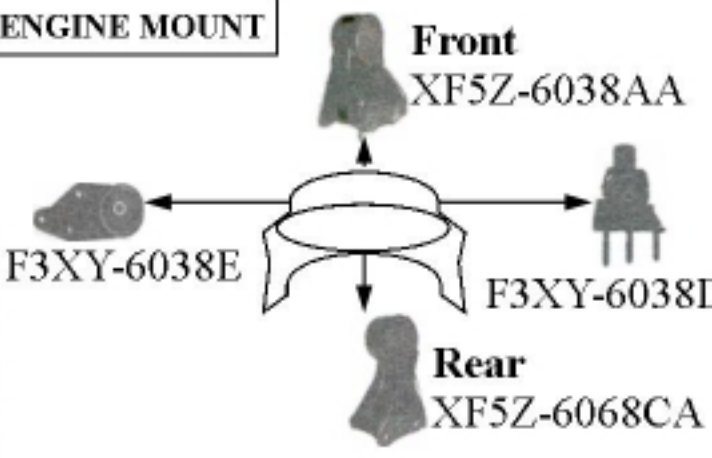

F8AZ-5K-484A
MARQUIS'99
STAB.LINK,F

VILLAGER 93-98

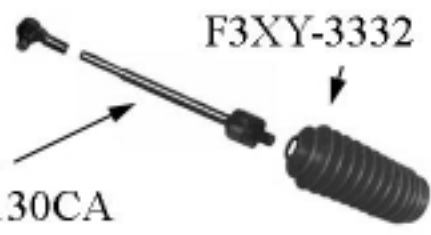

<p>RADIATOR HOSE</p>  <p>Lower F4XY-8286A</p>  <p>Upper F4XY-8260A F6XZ-18472AA</p> 	<p>STEERING PUMP</p>  F3XY-3A713F  F3XY-3A713D  F3XY-3A713C  F3XY-3A713E	<p>ENGINE MOUNT</p>  <p>Front XF5Z-6038AA</p> <p>Rear XF5Z-6068CA</p> <p>F3XY-6038E F3XY-6038D</p> <p>F3XY-7A031A Oil Hose F3XY-6A664BA Oil Hose F6XZ-7A030AA Oil Hose</p>
---	--	--

<p>DRIVE AXLE</p>  Boot Inner F3XY-3A331 <p>Boot Outer F3XY3A331A</p>	<p>STEERING LINK</p>  Bushing Steering R F3XY-3C716A  L F3XY-3F640A	<p>End Tie Rod XF5Z-3A130AA</p> <p>Boot F3XY-3332</p>  <p>Rack End XF5Z-3A130CA</p>
--	---	--

<p>FRONT SUSPENSION</p>  Arm Lwr Control	<p>REAR SUSPENSION</p>  <p>Rubber Bush F3XY-5781B</p> <p>Bushing Leaf Spring F3XY-5781AA</p> <p>Link Kit F3XY-5C486AA</p> <p>Bush F3XY-5L491A</p>
<p>Bush F3XY-3078BB</p> <p>Bush F3XY-3078SB</p> <p>1F5Z-18B028 XF5Z-18H198 F3XY-18A047</p> <p>Bush F3XY-5K486</p> <p>Link Kit F3XY-3A131A</p>	<p>Bush F3XY-5L491A</p>



<p>RADIATOR HOSE</p> <p>Upper</p> <p>Lower</p>	<p>ENGINE MOUNT</p> <p>Front F32Z-6038A</p> <p>Right F32Z-6038M</p> <p>Man F32Z-6038F</p> <p>Auto F32Z-6038GA</p> <p>Auto F32Z-6068B</p> <p>Man F32Z-6068A</p>
<p>DRIVE AXLE</p> <p>Boot Inner F32Z-3A331F</p> <p>Boot Outer F32Z-3A331E</p>	<p>STEERING LINK</p> <p>End Assy Tie Rod F32Z-3A130A</p> <p>Boot F32Z-3332</p> <p>Rack End F32Z-3280A</p>
<p>FRONT SUSPENSION</p> <p>Bush R F32Z-3069BR L F32Z-3069CL</p> <p>Original Quality F42Z-3069A</p> <p>F32Z-18A161A</p> <p>F32Z-18A047</p> <p>F32Z-18A085</p> <p>Bush F32Z-5493B</p> <p>Link R F32Z-5K484R L F32Z-5K484L</p>	<p>REAR SUSPENSION</p> <p>Link Rear Lateral R F32Z-5500BR L F32Z-5500AL</p> <p>Link Front Lateral F32Z-5500DC</p> <p>Link Trailing F32Z-5K898B</p> <p>F32Z-18192A</p> <p>F32Z-18A047A</p> <p>F32Z-18159A</p> <p>Bush F32Z-5493A</p> <p>Link F32Z-5664A</p>

FORD Replace parts

CONTOUR / MYSTIQUE

1995-2000



RADIATOR HOSE

Upper
LHC5052



Lower

ENGINE MOUNT

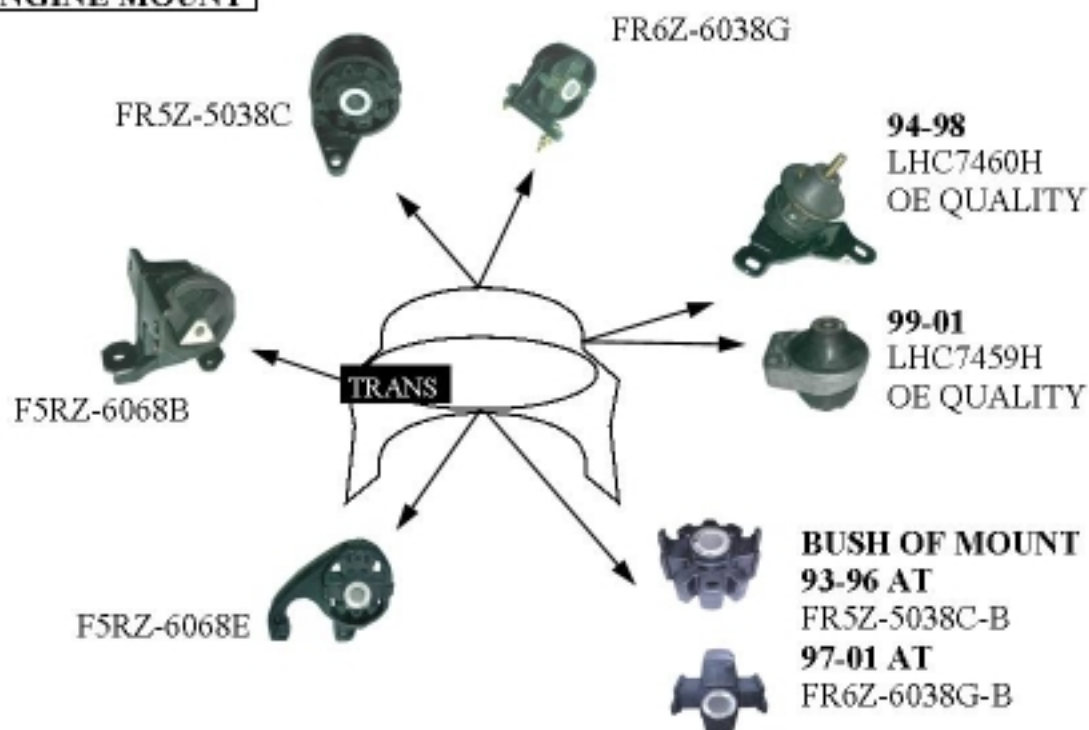

DRIVE AXLE

Outer:
F5RZ-3A331A



Inner:
F8RZ-3A331A

STEERING LINK



F5RZ-3280B



F3RZ-3332A

F3RZ-3A130BA

FRONT SUSPENSION

Bush
F5RZ-3078B-SB



Arm:
RH:F5RZ-3078B
LH:F5RZ-3079B

BUSH
F5RZ-3078B-BB



F5RZ-3A197A

F5RZ-5493A



YS7Z-5K484A

F5RZ-3020A

F5RZ-18A047

REAR SUSPENSION



F5RZ-5A486A

F5RZ-18198A



F5RZ-5K570A



F5RZ-5493A

Bush:
F5RZ-5500B-B



Front Arm:
F5RZ-5500B

Rear Arm:
F5RZ-5500A



Bush:
F5RZ-5A638A

Trailing Arm
F5RZ-5K898A



KNUCKLE BUSH
OD. 36.6mm ; F5RZ-5A638A
OD. 38.4mm ; F5RZ-5A638B

Bush:
F5RZ-5A638B



RADIATOR HOSE

UPPER



2.0L:YL8Z-8260AD 3.0L:YL8Z-8260BM

LOWER



2.0L:YL8Z-8286AE 3.0L:YL8Z-8286BE

ENGINE MOUNT



MID: YL8Z-6A061AB



LOWER:YL8Z-6B072CA

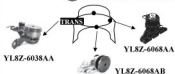

DRIVE AXLE



Front Outer
YL8Z-3A331CA
Front Inner
YL8Z-3A331BA

STEERING LINK



YL8Z-3A130GA



YL8Z-3280EA

FRONT SUSPENSION

BUSH:
YL8Z-3069AA



BALL JOINT:
3L8Z-3078AB-BJ

LOWER ARM
RH:3L8Z-3078AB
LH:3L8B-3079AB

BUSH:
3L8Z-3078AB-BB

YL8Z-18183AB



YL8Z-18A179AA



YL8Z-18A085AB



F3XY-5K486A



3L8Z-5K483AA

REAR SUSPENSION



Upper
RH:YL8Z-5500AA
LH:YL8Z-5500AB



Lower
RH:YL8Z-5500AC
LH:YL8Z-5500AD

Bush: 3L8Z-5K827BA

STRUT BUMPER
YL8Z-18159AA



REAR DIFFERENTIAL



FRONT:
YL8Z-4K205AA

REAR:
YL8Z-4K204AA



CHRYSLER Replace parts**LONGHO****AUTOMOBILE RUBBER PARTS**
LONG HO INDUSTRY RUBBER CO., LTD.

LHC3117

CHRYSLER
STRUT MOUNT4668182
NEON 95-99 AT
ENG. MOUNT, LH4668200
NEON 95-99
ENG. MOUNT FRONT

LHC1716

CHRYSLER
MUFFLER HANGER4668257-B
NEON 95-99
BUSH OF MOUNT, R4668259
NEON 95-99 AT
ENG. MOUNT R

LHC3592

G.W., CHRYSLER
POWER PUMP CAP4509774 RH
4626273 LH
NEON '96
CONTROL ARM, LOWER

LHC6758

04764091
CONCORDE '93
STAB. KIT, FBush
LHC7043 LHC7245LHC4524
4626446LHC4523
4626447
NEON 95-99
ARM BUSH4582855
CONCORDE '93
STAB. KIT, R4616578 RH
4616579 LH
STRATUS
CONTROL ARM, LOWERLHC5102
NEON '95
HOSE, LOWER

LHC6760

4694855
CARAVAN '93
STAB. KIT, F4695831A
STRATUS
STAB. KIT, RLHC5101
NEON '95
HOSE, UPPERLHC6761
4695626
STRATUS
STAB. KIT, FLHC7261
NEON 95-99
STRUT MOUNT, FLHC6762
52002609
WRANGLER 2.5
LINK, FLHC7262
NEON 95-99
STRUT MOUNT, RLHC6763
NEON
STAB. KIT, FLHC6759
04626766
NEON '94
BAR LINK, R

CHRYSLER, DODGE

REPLACE PARTS

LONGHO RUBBER

TEL: 886-2-27603976

FAX: 886-2-27603477

E-MAIL: longho@ms26.hinet.net

CARAVAN



5272190
CARAVAN 91-95
STAB.KIT,R

CHEROKEE



52003360
CHEROKEE
84-96
STAB.KIT,F



52088437
CHEROKEE
96-98
STAB.KIT,F

RAM DODGE



52038665
RAM DODGE'94
STAB.KIT,F



52106481
RAM DODGE'99
STAB.KIT,F



LHC4086
 2805510
 CHEV
 ARM BUSH, UPPER



LHC3913
 47.5x55x128
 GM CAMIRA
 STEERING BOOT



LHC4085
 2807244
 CHEV
 ARM BUSH, LOWER



LHC3914
 35.7x55x128
 GM CAMIRA
 STEERING BOOT



LHC4478
 7433702
 GM ATM
 PEDAL PAD



LHC7076
 8821489
 GM
 ARM BUSH



LHC7077
 8824233
 GM
 ARM BUSH

	LHC1721 GM ENG. MOUNT, R		LHC1731 GM STEERING RUBBER		LHC1741 GM CV JOINT BOOT
	LHC1722 GM ENG. MOUNT, R		LHC1732 GM STABILIZER KIT		LHC1742 GM CV JOINT BOOT
	LHC1723 GM 2.8 ENG. MOUNT, F		LHC1733 GM BUICK STABILIZER BUSH		LHC1743 DODGE TC3 CV JOINT BOOT
	LHC1724 GM 2.8 ENG. MOUNT, F		LHC1734 GM OLDSMOBILE STABILIZER BUSH		LHC2002 8-94208-053 CHEV PICK UP WHEEL REPAIR KIT
	LHC1725 EM1083 CHEVORLET ENG. MOUNT, F		LHC1735 GM 2.5 RADI. HOSE, UPR		LHC1744 GM LINK BUSH
	LHC1726 8-02875-013 GM LINK GROMMET		LHC1736 GM 2.5 RADI. HOSE, LOR		LHC1745 CHEVOLET SUSP. BUSH
	LHC1727 GM ENGINE ROD		LHC1737 GM BUICK 2.8 RADI. HOSE, UPR		LHC1746 CHEVOLET SUSP. BUSH
	LHC1728 GM STEERING BOOT		LHC1738 GM BUICK 2.8 RADI. HOSE, LOR		LHC3119 G.M. STRUT MOUNT
	LHC1729 GM '80 CV JOINT BOOT		LHC3180 CORSIKA HOSE, UPPER		LHC5050 9.5x440x80G GM 88 2.0 SUNBIRD EMISSION HOSE
	LHC1730 GM STEERING RUBBER		LHC3343 32x41x480 CORSIKA RADI. HOSE, LOWER		



AUTOMOBILE RUBBER PARTS

LONGHO











LONG HO INDUSTRY RUBBER CO., LTD.

G.M. Replace parts

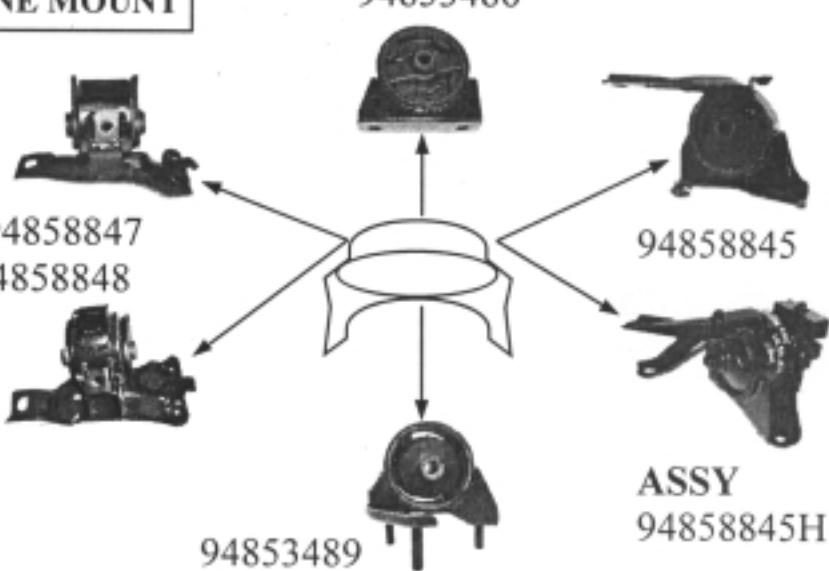
 <p>LHC3178 SKYHAWK, CAVALIER HOSE, UPPER</p>	 <p>LHC4036 GM 2.8 '89 BUFFER</p>	 <p>LHC3145 PONTIAC 2.0 STRUT MOUNT, F</p>
 <p>LHC3179 SKYHAWK, CAVALIER HOSE, LOWER</p>		 <p>LHC3144 PONTIAC 2.8 STRUT MOUNT, F</p>
 <p>LHC3054 SUNBIRD HOSE, UPPER</p>		 <p>LHC3141 OLDSMOBILE STRUT MOUNT, F RH</p>
 <p>15665555 RH 15665554 LH GM '90 C-40 LOWER ARM</p>		 <p>LHC3142 OLDSMOBILE STRUT MOUNT, F LH</p>
 <p>10048517 RH 10048518 LH GM 2.0 2.3 SUSPENSION</p>		
 <p>14082846 LH 14082847 RH GM 2.8 SUSPENSION ARM</p>		
 <p>10000334 CAPRICE REAR LINK</p>		
 <p>10000887 CAPRICE REAR LINK</p>		

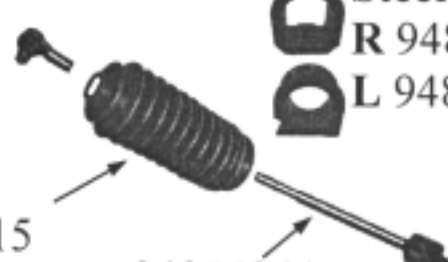
PRIZM 93-97

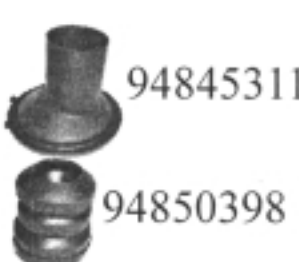

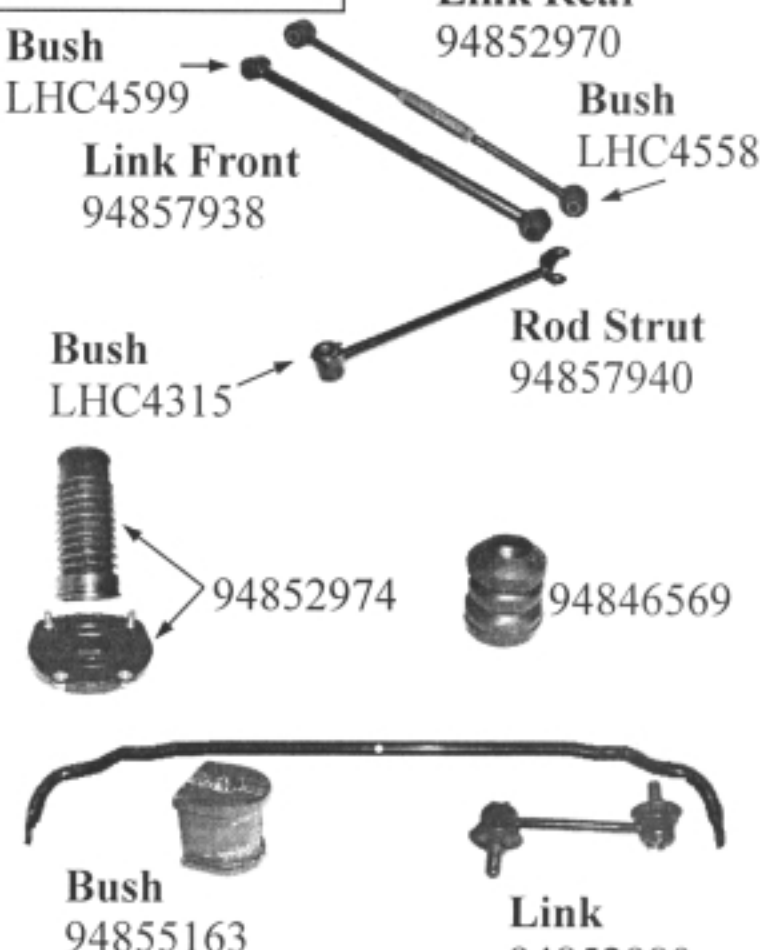
<p>RADIATOR HOSE</p> <p>Upper 1.6CL 94853512</p>  <p>Upper 1.8CL 94853514</p>  <p>Lower 1.6CL 94853513</p>  <p>Lower 1.8CL 94853515</p> 	<p>ENGINE MOUNT</p> <p>94853486</p>  <p>MT 94858847 AT 94858848</p> <p>94853489</p> <p>94858845</p> <p>ASSY 94858845H</p>
<p>DRIVE AXLE</p> <p>Boot Inner LHCV3120</p>  <p>Boot Outer LHCV2049</p> 	<p>STEERING LINK</p> <p>End Tie Rod 94854303</p>  <p>Boot Manu 94852915 Power 94852842</p> <p>94855844</p> <p>Steering Bush R 94851644 L 94852816</p> 
<p>FRONT SUSPENSION</p> <p>Joint Ball 94854914</p>  <p>Bush Assy R 94852920 L 94852921</p> <p>Bush 4865412031</p> <p>Arm Control</p>  <p>94854736</p> <p>94845311</p> <p>94850398</p> <p>Bush LHC4344</p> <p>Link LHC9030</p> 	<p>REAR SUSPENSION</p> <p>Bush LHC4599</p> <p>Link Front 94857938</p> <p>Bush LHC4558</p> <p>Rod Strut 94857940</p> <p>Bush LHC4315</p> <p>94852974</p> <p>94846569</p> <p>Bush 94855163</p> <p>Link 94852980</p> 



RADIATOR HOSE



ENGINE MOUNT

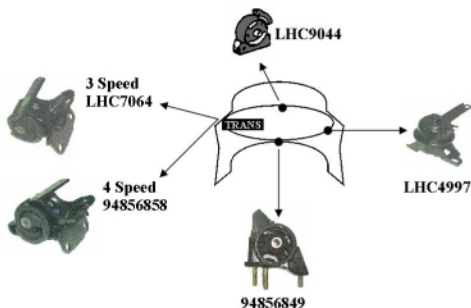

DRIVE AXLE



STEERING LINK



FRONT SUSPENSION



REAR SUSPENSION



GM Replace parts
GEO METRO 89-01

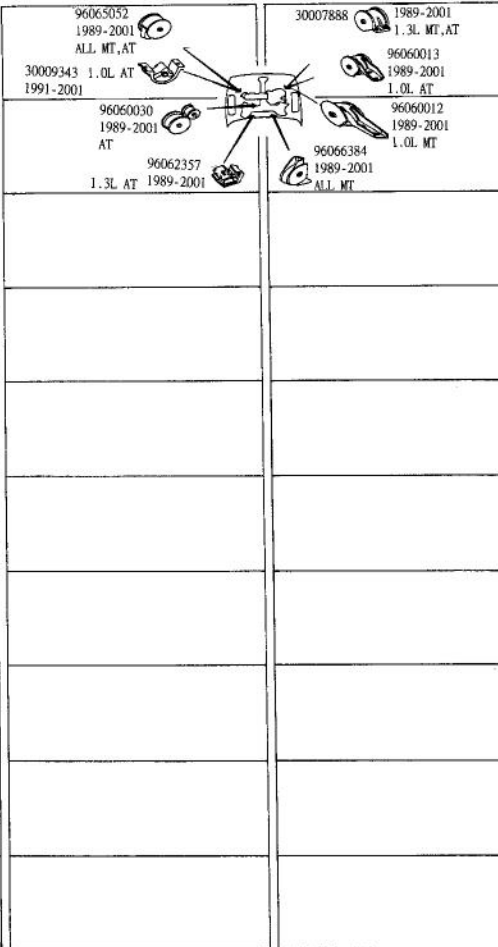
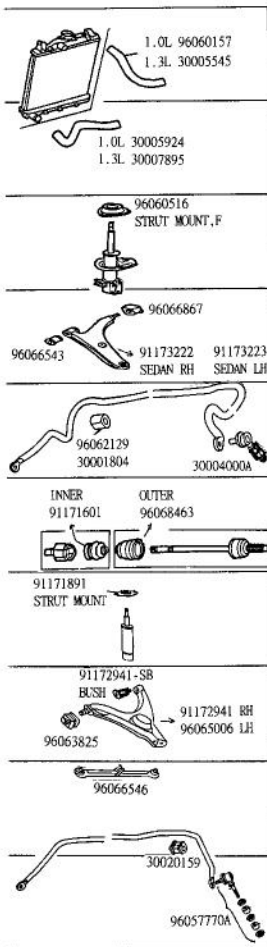

GM Replace parts
GEO, CHEVROLET TRACKER 89-01

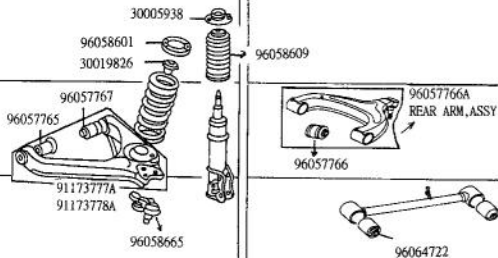
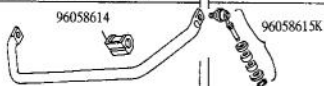
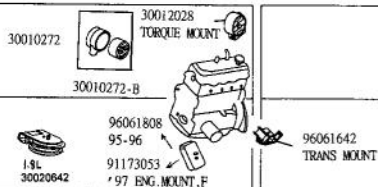

CHEVROLET replace parts TRACKER 1999-2004



RADIATOR HOSE

Upper



1.6L:
30021714

2.0L:
30027980

2.5L:
30027981

Lower



1.6L:
30027983

2.0L:
91177033

2.5L:
30027984

ENGINE MOUNT

1.6/2.0/2.5L
LHC4799

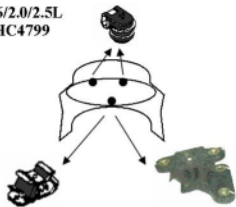

MT:
96061642

AT:
30020646

DRIVE AXLE



Outer:
91175358

Inner:
91174740

Bush:
96058373

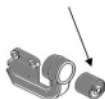

STEERING LINK



Tie Rod End
RH: 91174753
LH: 91174754

Boot
RH:91175533
LH:91175532



Rack End
91175548

FRONT SUSPENSION

Arm
RH:91175489
LH:91175490

Bush Rear
91175462

Bush Front
91175461

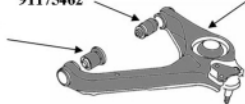

30021924

30022595



91175227



30023300K

REAR SUSPENSION

Upper Link
30020951
Bush
LHC8182

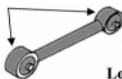

Lateral Link
LHC8390

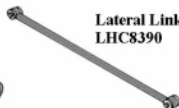

Lower Link
30023945



Bush
30023945-B